

MAVI
A FREEFLY SYSTEMS INNOVATION

USER GUIDE





Freefly represents the intersection of art and technology. Our team consists of industry leading specialists all focused on one task - inventing solutions to allow unrestricted camera movement. Freefly initially created the CineStar line of multi-rotor camera platforms, which allowed smooth, stable and dynamic low-altitude aerial imagery. After years of research and development in camera stability, Freefly has created the MōVI stabilized camera gimbal. Our goal with the MōVI is to empower a new era of stabilized cinematography on a variety of platforms, from handheld to helicopters and everything in between.



IN·ER·TIA

The Freefly MōVI is a digital 3 axis stabilization system that relies on both active motor driven components and passive inertial stabilization. Passive stabilization relies on the principles of inertia (tendency of an object to resist change in its motion) and requires that the camera is well-balanced in the Pan, Tilt, and Roll Axes. Active stabilization refers to the techniques of using sensors to measure the camera's Pan, Tilt, and Roll movements and counteract those movements using motors attached to the 3 axes. These 2 types of stabilization work in concert to achieve the smooth and stable shots for which the MōVI is well known.

This manual will teach you how to setup, balance, and tune your MōVI M5. For new users, the process of balancing and tuning a MōVI might seem overwhelming at first, so allow some time to master the procedures described in this manual.



MöVI

COMPONENTS:

- 1. Pan Motor
- 2. Pan Axis
- 3. Roll Motor
- 4. Roll Axis
- 5. Tilt Motor
- 6. Tilt Axis
- 7. Tilt Front to Back Adjustment
- 8. Roll Adjustment Point
- 9. Tilt Vertical Adjustment

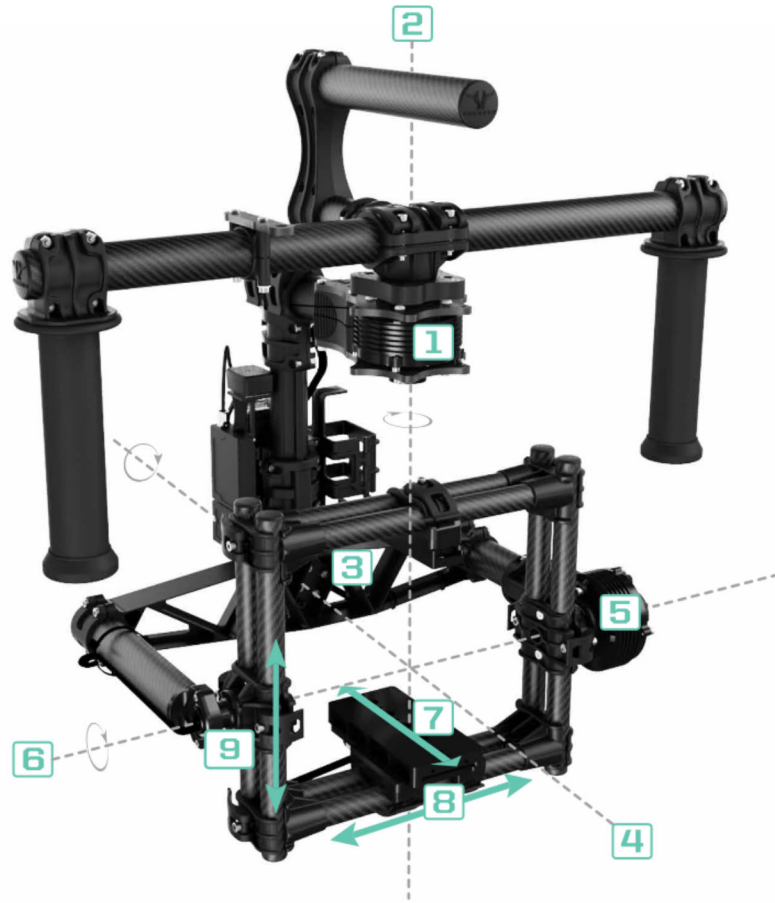

CONTENTS

01 GETTING STARTED

Batteries and Battery Charger:

- Charging the Battery
- Installing the Battery
- Mounting the Camera

02 BALANCING the MōVI

Step 1: Tilt Front to Back Balance

Step 2: Tilt Vertical Balance

Step 3: Roll Balance

Step 4: Pan Balance

03 CONVERTING M10 to MR

- Attaching Landing Gear Legs & Octo Suspension Plate
- Bluetooth Pairing/Freefly Configurator Connection

04 GUI/TUNING

Initial Tuning

Majestic Tuning

Pan Majestic Tuning

Tilt Majestic Tuning

GUI Parameter Definitions

05 REMOTE CONTROL

Remote Control Features

Mode Switch (Dual Operator, Majestic, Kill)

06 TROUBLESHOOTING

Symptoms, Possible Causes and Solutions



NOTICE

All instructions, warranties and other documents are subject to change at the sole discretion of Freefly Systems Inc. ("Freefly"). For up-to-date product literature, visit www.freeflysystems.com.

DISCLAIMER

This is a sophisticated cinema product. It must be operated with caution and common sense and requires some basic mechanical ability. Failure to operate this product in a safe and responsible manner could result in injury or damage to the product or other property. This User Guide contains instructions for safety and operation. It is essential to read the entire User Guide and follow all instructions and warnings in the manual, prior to setup or use, in order to operate the MōVI correctly and avoid damage or injury.

Freefly has made every effort to provide clear and accurate information in this User Guide, which is provided solely for the user's knowledge. While thought to be accurate, the information in this document is provided strictly "as is" and Freefly will not be held responsible for issues arising from typographical errors or user's interpretation of the language used in this User Guide that is different from that intended by Freefly.

Freefly reserves the right to revise this User Guide and make changes from time to time without obligation to notify any person of such revisions or changes. In no event shall Freefly, its employees or authorized agents be liable for any damages or losses, direct or indirect, arising from the use of any technical or operational information contained in this document.

BOX CONTENTS

Qty 1 - MōVI M5 Handheld Stabilizer
Qty 1 - MōVI Top Handle
Qty 1 - Stand
Qty 2 - Freefly 14.8V 1.3Ah MōVI Batteries
Qty 1 - Freefly LiPo Charger with AC cord
and Charge Lead Adapter
Qty 1 - M2 Hex Driver
Qty 1 - M2.5 Hex Driver

OPTIONAL ACCESSORIES

Qty 1 - DX7 Transmitter*

*Included with DX7 Transmitter:

Qty 1 - 2000MAh NiMh Transmitter Battery Pack

Qty 1 - SD Card

Qty 1 - 12V DC Power Supply

Qty 1 - DX7s Neck Strap

Qty 1 - DX7s User Manual

GETTING STARTED





BATTERIES AND BATTERY CHARGER

WARNING: You must read these safety instructions and warnings carefully before charging or using your batteries. Failure to exercise caution while using Lithium Polymer (LiPo) batteries and comply with the following warnings could result in battery malfunction, electrical issues, excessive heat, fire, or injury and property damage.

GENERAL GUIDELINES AND WARNINGS

You must read these safety instructions and warnings carefully before charging or using your battery.

- Stop using or charging the battery immediately if the battery becomes or appears damaged, starts to balloon or swell, leaks, becomes deformed or gives off an odor, exceeds a temperature of 160°F (71°C), or if anything else abnormal occurs. Disconnect the battery and observe in a safe area outside of any building or vehicle for at least 45 minutes, as a damaged battery can experience a delayed chemical reaction that could possibly result in fire.
- Never disassemble, modify, puncture, shock, drop, crash and/or short circuit the battery. Leakage, smoke emission, ignition, explosion or fire can occur, which may result in personal injury or property damage.
- **DO NOT** leave the battery and charger unattended during use.
- Never drop charger or batteries.
- Never attempt to charge "dead" or damaged batteries.
- Never charge a battery if the cable has been pinched or shortened.
- Never allow minors to charge or use battery packs without adult supervision.
- Never allow batteries to come in contact with moisture at any time.

- Never charge or store batteries in extremely hot or cold places (recommended between 50°-80°F/10°-26°C), leave in a hot environment (inside an automobile in hot weather), or leave in direct sunlight.
- Never place or carry batteries in your pockets or clothing.
- Always use Freely-approved LiPo batteries.
- Always inspect the battery before charging.
- Always connect the positive red lead (+) and negative black lead (-) terminals of the battery to the charger terminals correctly.
- Always disconnect the battery after charging, and let the charger cool between charges.
- If a battery will not be used for more than one week, it is recommended that the battery is stored with a voltage of approximately 3.8V per cell. Do not store the battery fully charged. Store the battery at room temperature in a cool or shaded area (ideally between 50°-80°F /10°-26°C).
- Batteries should be stored in a vented, fire-resistant container. No more than two batteries should be placed in a container to avoid chain reactions. Storage temperatures should not fall below 32°F/0°C or above 130°F/54°C. Damaged batteries are extremely sensitive to temperature fluctuation and care should be taken in their immediate disposal. High temperatures may cause fire, even with undamaged batteries.

NOTICE: All instructions and warnings must be followed exactly. Mishandling of LiPo batteries can result in fire. By handling, charging or using the included LiPo batteries, you assume all risks associated with LiPo batteries. If you are not prepared to accept complete liability for the purchase and/or use of the batteries, you are advised to return them in new and unused condition to the place of purchase immediately.

IMPORTANT NOTE: If you are using the battery to power or charge an accessory used with the MōVI, it is your responsibility to constantly monitor the battery's voltage through the use of a voltage checker. If the accessory drains the battery below 3.0V per cell, it will damage the battery and render the battery unusable. Never attempt to charge a battery that has individual cell voltages below 3.0V.

CHARGING PROCESS WARNINGS AND SAFETY PRECAUTIONS

- **Never** charge or use a LiPo battery that shows any damage or disfigurement of any kind, as this may be a sign of internal damage. Any damage to the protective cover, wiring or plugs is also reason to discontinue use.
- **Never** leave the lead wires dangling from a battery.
- **Never** charge a battery unattended.
- **Never** connect more than one battery pack to the charger at a time.
- **Never** charge near moisture, extreme temperatures, flammable or combustible materials.
- **Never** charge the battery while installed on the MōVI or other equipment or while inside a vehicle.
- **Never** attempt to charge a battery that is damaged or has individual cell voltages below 3.0V.
- **Always** inspect batteries before charging.
- **Always** use a specific LiPo charger only. Do not use a Nickel-cadmium (NiCd) or Nickel-metal hydride (NiMH) charger, even though these chargers may appear similar to a LiPo charger. Failure to do so may cause a fire, which may result in personal injury and/or property damage.
- **Always** let the battery cool down to ambient temperature before charging.
- **Always** monitor the temperature of the battery while charging. If the battery becomes hot to the touch or begins to swell, discontinue charging immediately. Disconnect the battery from the charger and observe it in a safe place for at least 45 minutes.
- **Always** ensure that the proper cell count or voltage is selected on your charger for this battery. Failure to properly set the cell count or voltage could result in fire or explosion of the battery.
- For optimal performance and extended life, do not allow your battery voltage to drop below 3.4V. It is recommended that you use a voltage checker to actively monitor battery voltage.

BATTERY DISPOSAL:

NOTICE: LiPo batteries require special handling for safe disposal. The following steps must be taken to avoid damage or injury to yourself, your property or anyone who comes in contact with the battery.

If the battery is undamaged but no longer useful:

1. Discharge the battery to a maximum of 1.0V per cell using a safe discharge method.
2. Leave the battery uncharged and retest the battery after 24 hours. If the battery is over 1.0V per cell, repeat the procedure until the battery is 1.0V per cell or less.
3. Place electrical tape over each wire lead and tape the wire leads to opposite sides of the battery.
4. Place battery in a sealed plastic bag and place plastic bag in a vented, fire-safe container.
5. Use a fire-safe container to deliver battery to a recycling center authorized for LiPo batteries. Please note that not all battery-recycling services include LiPo batteries. If no LiPo recycling facility is available in your area, contact your state or local HAZMAT agency for instructions.

If the battery is damaged:

1. If the battery or wiring is damaged, please contact your state or local HAZMAT facility for instructions. Batteries must be rendered safe before being transported or recycled.
2. **DO NOT** transport or ship batteries which have more than 1.0V per cell charged OR that show signs of damage without following the instructions given by the HAZMAT agency.



CHARGING the BATTERY

1. Insert the AC power cord into the charger.
2. Insert the AC power cord into the wall socket. All LEDs will light for 1 second and the charge status LED will flash green, which indicates the charger is ready to charge.
3. Select "LiPo" on the battery type switch.
4. Select the "1A" charging current on the charge current switch when charging the included batteries.
5. Connect battery main charge lead to the charge lead input in the front of the charger. Make sure the red plug is plugged into the red charge socket and the black plug is plugged into the black charge socket.
6. Connect the Freely 4s 1.3Ah battery to the charge lead. Always connect the positive red lead (+) and negative black lead (-) terminals to the corresponding colored terminals on the charger.
7. Connect the battery balance lead to the "4S" balance socket on the side of the charger. The charger will automatically start charging.
8. The charge status LED and the cell status LED will light constant red. The cell 1-4 LED's will glow continuously indicating a 4 cell battery pack.
9. When the battery is fully charged, the "charge status" LED will glow constant green.
10. Unplug the battery from the balance port and charge lead. The battery is ready for use in your M6VI M5.

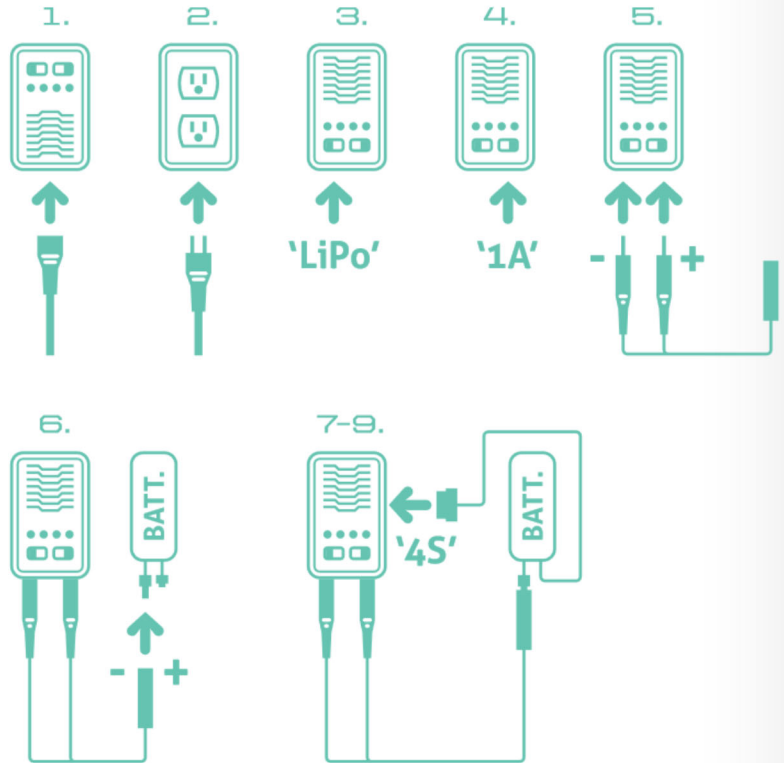

INSTALLING BATTERY in the MöVI

The MöVI battery is custom designed to fit snugly in the MöVI battery compartment. The battery is retained using a lightweight plastic latch mechanism. Be careful when installing/removing the battery to avoid damaging the battery lead and balance lead.

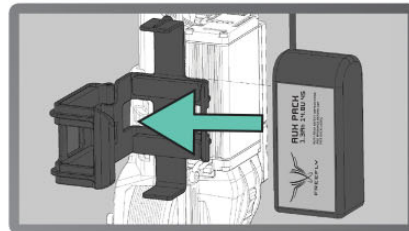
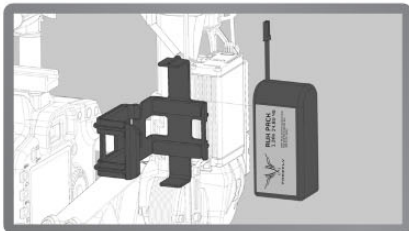

1. Insert battery into battery compartment observing proper orientation (Freely sticker visible).

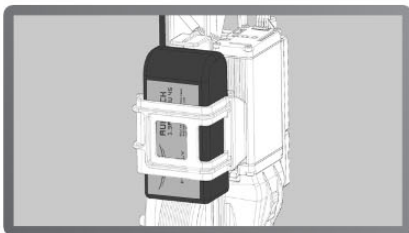

2. Engage battery latching mechanism.

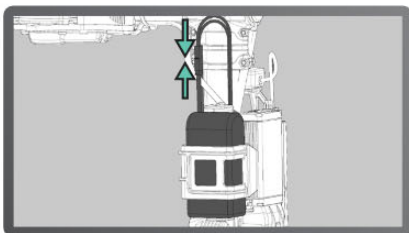

3. Ensure the MöVI power switch is set to "off" and plug the battery into the power input connector on the MöVI.
Note: The battery and input connector are keyed. Do not force the battery and input connector together.

Battery Specification

Battery Type: Lithium Polymer
Capacity: 1.3Ah
Voltage: 14.8v
Max Continuous Discharge: 3C (3.9A)
Max Burst Discharge: 5C (6.5A)
Max Charge Voltage: 4.2V per cell
Minimum Discharge Voltage: 3.0V per cell
Dimensions: [69mm (L) x 34mm
(W) x 28mm (H)]
Weight: 125g

Charger Specification

AC Input Voltage: 100-240V, 50-60HZ
Output Power: 20W
Charging Current (Selected by Switch):
1A, 2A, 3A
Current Drain for Balancing: 200mA
4 LEDs for Balancing Indicator
1 LED for Charging Status



MOUNTING the CAMERA

The MōVI uses a custom lightweight adjustable camera rail to allow you to easily balance, install, and remove your camera package. It is important that you fully build your camera package prior to installing it on the M5. Adding accessories after balancing the M5 would necessitate re-balancing, so it is best to install all accessories (follow focus motors, receivers, batteries, etc.) prior to mounting the camera to the MōVI.

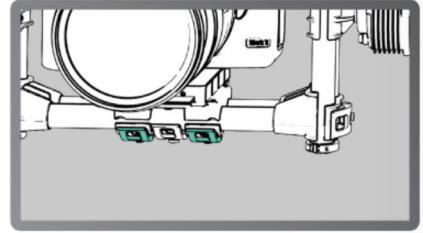
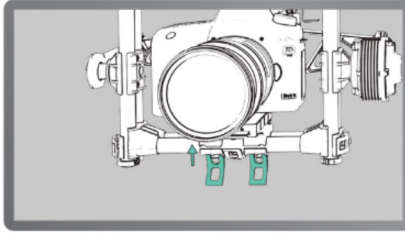

1. Attach the bottom camera rail to your camera using the provided $\frac{1}{4}$ - 20 screw. Please note that there are multiple attachment holes in the camera rail to choose from to cater to different camera layouts.

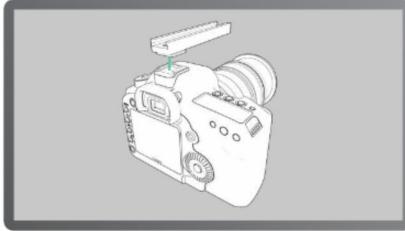

2. Install the hot shoe adapter into the hot shoe of your camera.

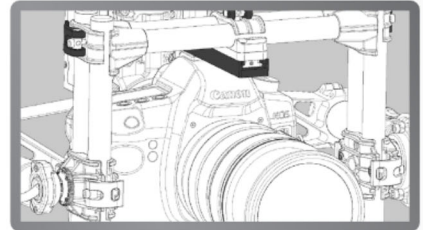
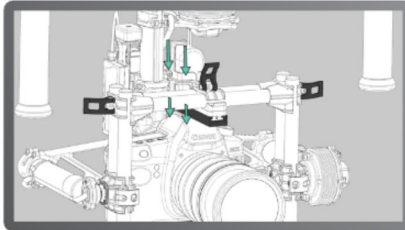

3. Attach the top camera rail to the hot shoe adapter using the provided M3x6 flat head screws.

One of the most critical factors in achieving optimal performance from the MöVI is proper balancing. The better the camera is balanced, the less work the motors have to do to achieve a stable shot. Accurate balance is highly critical in shots where the MöVI will be subjected to extreme movements or accelerations (running, horseback, biking, car mount, helicopter, etc.).

There are 3 Axes we need to accurately balance prior to turning the MöVI on and setting up the software. To reiterate, the camera needs to be fully setup with all accessories prior to installing and balancing the camera on the gimbal. The addition of accessories (follow focus motors, receivers, etc.) will cause the balance to shift, so they need to be installed prior to beginning the balancing process.

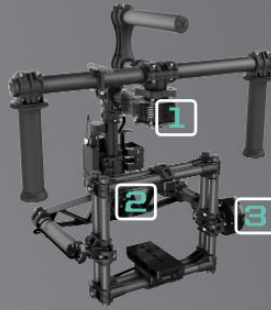

BALANCING the MöVI



STEP 1

TILT FRONT-TO-BACK BALANCE:

The goal with Step 1 is to balance the camera front-to-back on the Tilt Axis. When the proper front/back tilt balance is achieved, the camera will stay level if you remove your hands. Please note that to confirm proper tilt front/back balance, the camera and Tilt Axis need to be level. At this stage, we have not balanced the camera vertically for the Tilt Axis, so it is only possible to confirm tilt front/back balance when the camera and tilt axis are level. If the camera is sitting too low or too high with respect to the Tilt Axis, it will mask the issue of front to back balance. To adjust the balance, loosen the single middle toggle clamp under the camera and the single middle toggle clamp on top of the camera. This will allow the camera and mount plates to slide forwards and backwards. Be careful to ensure that the clamps are fully engaged and the camera is securely mounted to the adjustable camera plates as you complete step 1.



slide adjustable camera plates to balance tilt axis

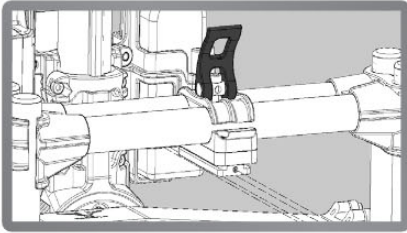

1. Loosen the top and bottom camera rail toggle clamps.

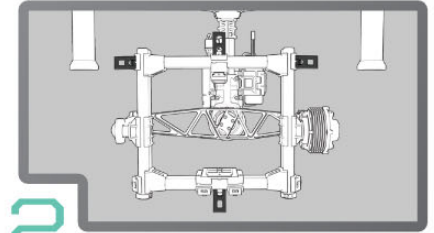
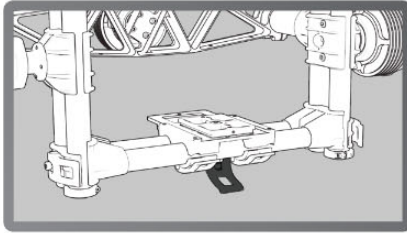

2. Loosen the side clamps on the top horizontal cross bar so that it can move freely up and down to allow you to set the correct height when installing the camera and adjustable camera plates.

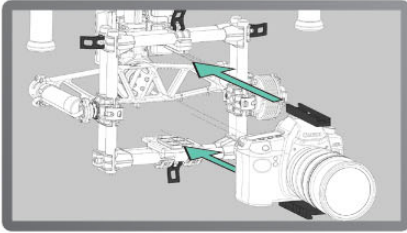

3. Slide the camera and mount plates onto the top and bottom camera mounts.

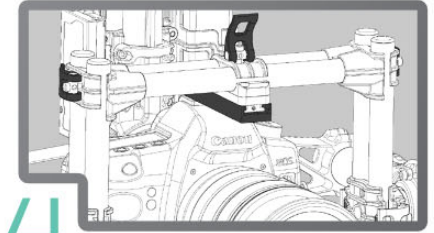
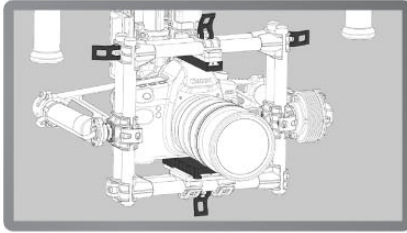

4. Tighten side clamps on the top horizontal cross bar once both the top and bottom camera rail are engaged on the camera plates.

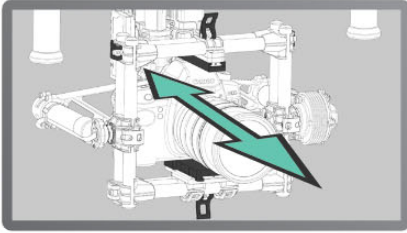

5. Slide the camera forward or backwards until the Tilt Axis remains level.

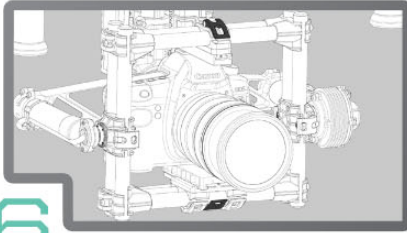

6. Tighten the top and bottom middle toggle clamp to lock the camera plate in position.
Note - Please be sure the toggle clamp is adequately tight. The toggle clamp holds the camera and camera rail onto the MöVI, so it is important it is securely clamped.



STEP 2

TILT VERTICAL BALANCE:

Now that we have successfully balanced the Tilt Axis front-to-back, we need to adjust the Tilt Axis vertical balance. To adjust the vertical balance, there are 4 toggle clamps on the middle of the four small side tubes. Adjust the camera position vertically until it is balanced such that you can rotate the camera to any tilt angle and it will naturally stay wherever you leave it. If you point the lens down and it wants to continue tilting forward on its own, then it is top heavy and the camera needs to shift down vertically. If you point the camera lens down and it wants to return to level, then you know it is bottom heavy and the camera needs to shift upwards vertically.



adjust height of crossbar to achieve tilt vertical balance

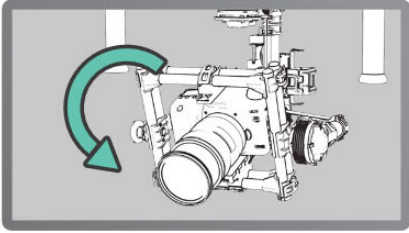

1. Identify which way the camera needs to be adjusted by tipping the camera lens down 20 degrees. If the camera returns to horizontal, then the Tilt Axis is bottom heavy. If the camera continues to rotate down when released, then Tilt Vertical Axis is top heavy.

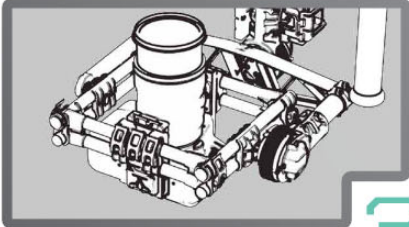

2. Rotate the Tilt Axis so that the camera lens is pointing straight up.

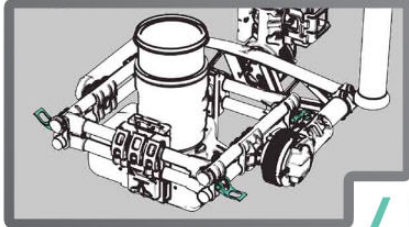

3. Loosen the 4 vertical adjustment toggles.

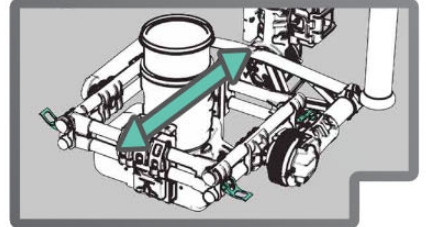

4. Slide the camera cage and camera forward or backward until the camera remains pointing straight up when released.

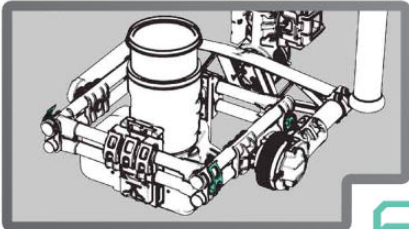

5. Tighten the toggles.

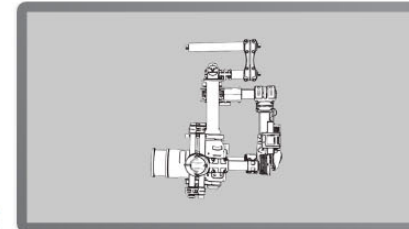

6. Confirm good balance by moving the camera to several tilt angles and confirming that it holds the given angle without user input.

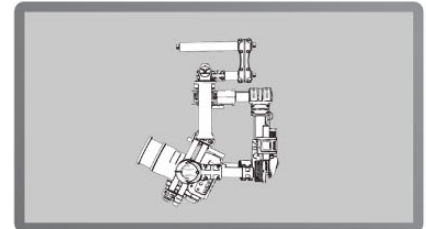



STEP 3

ROLL BALANCE:

With the Tilt Axis completely balanced, we can move onto balancing the Roll Axis. To adjust roll balance we need to loosen the 2 bottom outer toggle clamps and the top toggle clamp. This will allow the camera and cage to slide side-to-side to achieve roll balance.



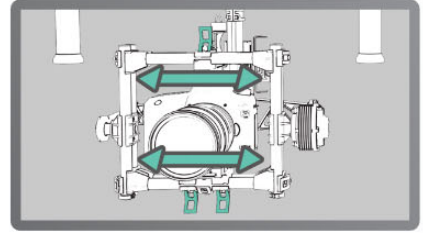
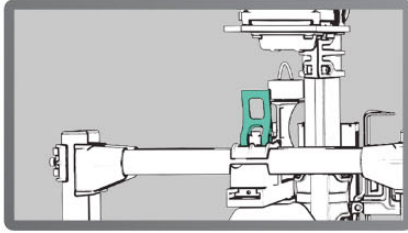
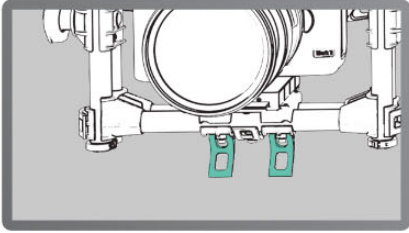

1. Loosen the 2 lower outer toggle clamps and 1 upper outer toggle clamp on the camera platform and slide camera and platform side-to-side to achieve proper balance.

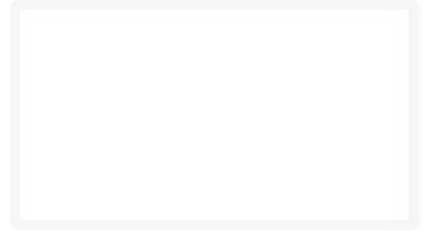
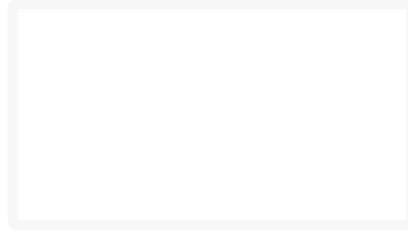
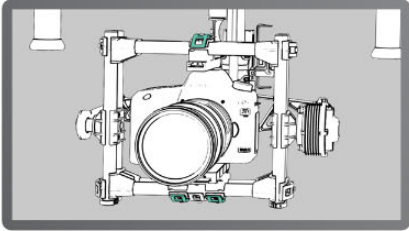

2. Tighten the 2 lower outer toggle clamps and 1 upper outer toggle clamp and upper clamp to lock roll in place.

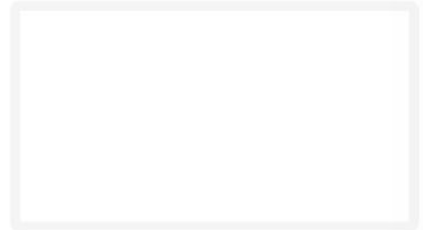
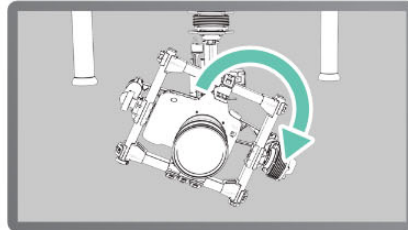
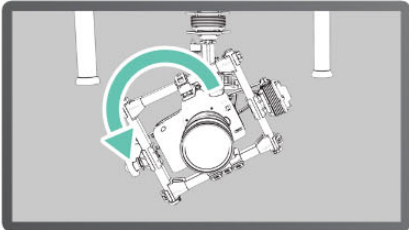

3. Confirm roll balance by moving Roll Axis to several locations and ensuring the axis will hold the given angle without user input.



STEP 4

PAN BALANCE:

Pan is perhaps the most difficult axis to visualize balancing. The end goal is that the entire mass below the pan motor would be balanced on the central axis line of the pan motor. The easiest way to check for Pan Axis balance is to slightly tilt the MōVI in the stand and see which way the Pan Axis swings. The clamp that holds the vertical tube to the top horizontal tube is the only adjustment for Pan Axis balance. By sliding this joint fore/aft we can achieve proper Pan balance.

2- slide pan knuckle to adjust pan balance

1- tip the gimbal to check pan axis balance

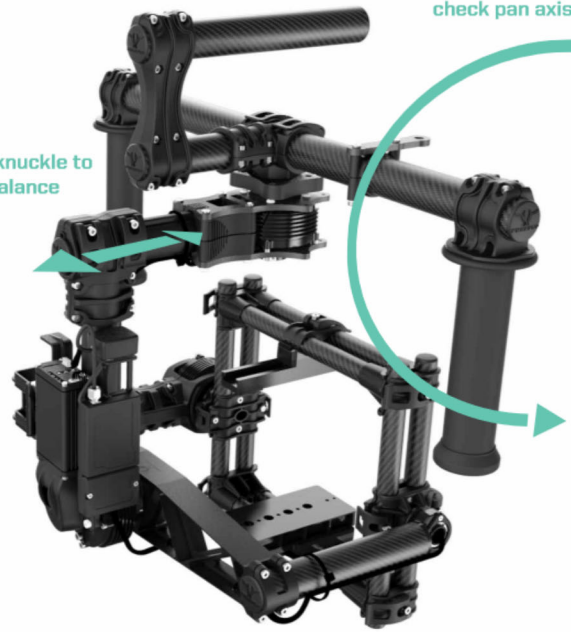

FORE/AFT PAN BALANCE:

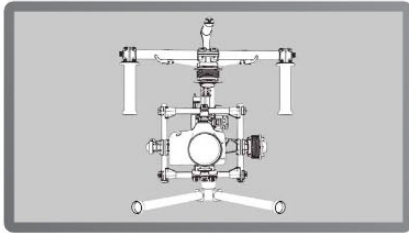

1. Mount the MöVI in the stand with the power off.

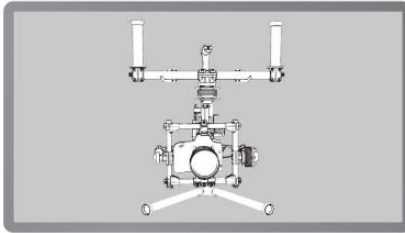

2. Loosen the 2 handle toggle clamps and rotate the handlebar upwards.

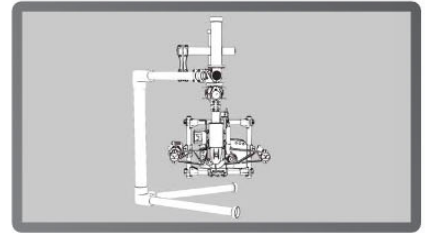

3. Align the MöVI such that the camera lens is lined up with the long top handle bar.

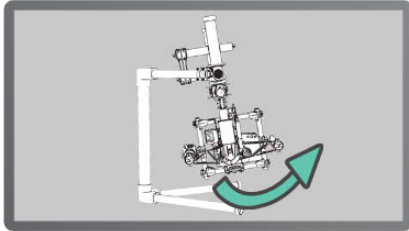

4. Using the handles, rotate the MöVI 5-10 degrees and observe which way pan rotates

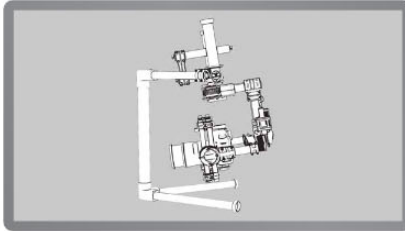

5. If the lens points to the low side, it indicates that the MöVI is nose heavy and the Pan knuckle needs to slide backwards.

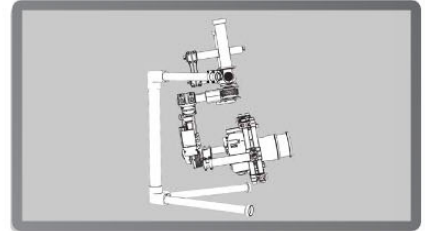

6. If the back of the gimbal points to the low side, it indicates that the MöVI is tail heavy and the Pan knuckle needs to slide forwards.

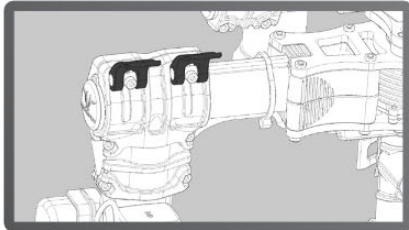

7. Loosen the 2 toggle clamps on the Pan knuckle to allow the knuckle to slide.

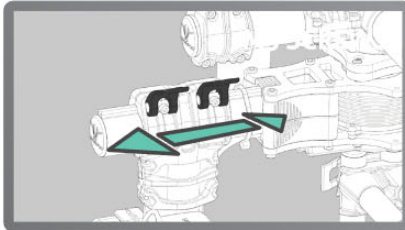

8. Slide the gimbal in the direction needed as indicated in Steps 5 and 6. Tighten the 2 Pan toggle clamps.

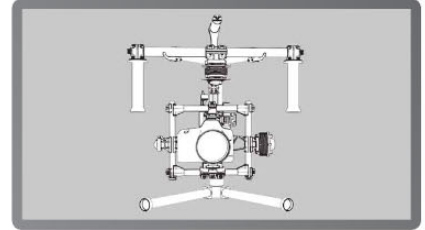

9. Confirm that the camera will not swing to the left or right when you rotate the MöVI handles 5-10 degrees. This indicates proper fore/aft balance.



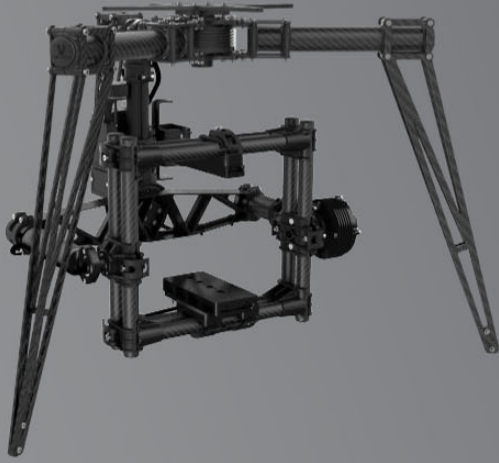

CONVERTING M5 to MR





M5 to MR

CONVERSION:

The M6VI M5 is designed to quickly transform to the Multi-Rotor (MR) version. The following steps will allow you to convert your M5 to MR and mount the gimbal to a CineStar multi-rotor.



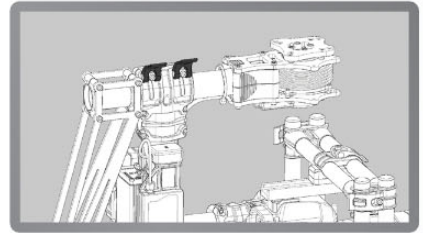
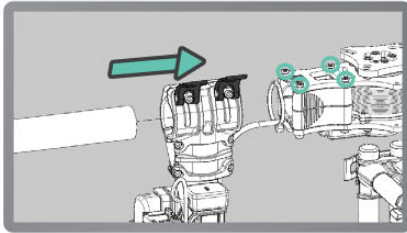
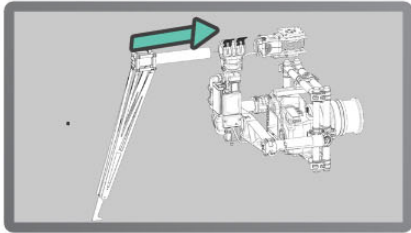

1. Replace the aluminum stepped tube with the 180mm carbon tube. You will need to loosen the 4 screws holding the aluminum tube to the Pan motor housing and slide it out. In its place, install the carbon tube with the rear landing gear attached.

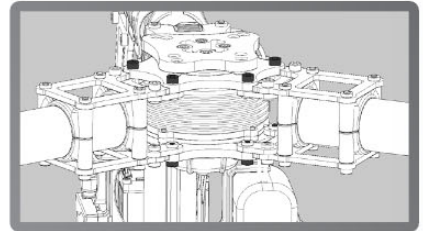
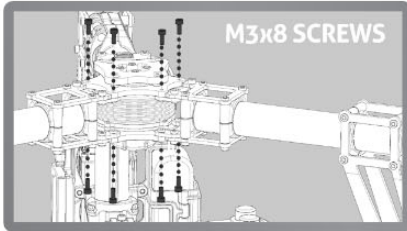
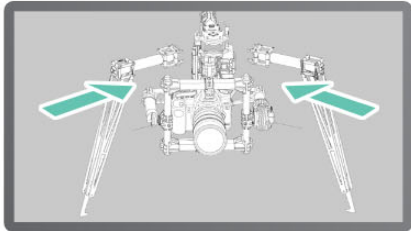

2. Attach the left and right landing gear legs and tubes to the M5 using the provided M3x8 Socket Head Cap Screws.

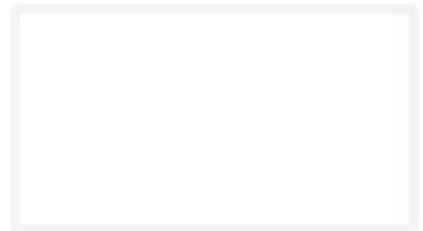
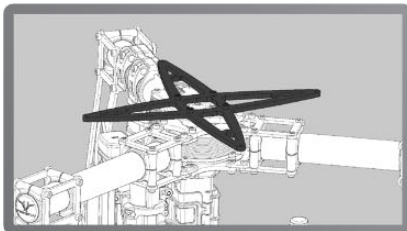
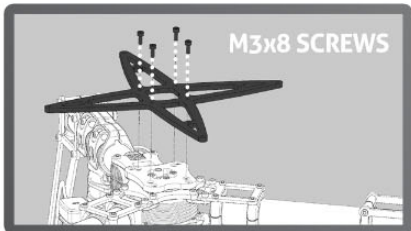

3. Attach the Octo Suspension Plate using the provided M3x8 Socket Head Cap Screws.

BLUETOOTH PAIRING GUIDE AND CONNECTION TO FREEFLY CONFIGURATOR for Android, PC and MAC:

For connectivity to an iOS device, please refer to the Wi-Fi Adapter Installation Manual found at <http://freeflysystems.com/software-manuals/>.

1. Power the MöVI stabilizer and wait for it to boot correctly. Under control panel → Hardware and Sound → Bluetooth Devices
Click on "Add Wireless Device". This window may also be accessed by clicking on Bluetooth Icon at bottom right of the screen.
2. Select the MöVI stabilizer device (the name may have been customized or changed).
3. Click on "Enter the device's pairing code".
4. Enter the password "1234" and click "Next".
5. Bluetooth pairing process should start, and then complete—click "Close".
6. The MöVI should now be successfully paired and available for use by the GUI. Right-click on the icon and select "Properties", then click on "Services" to find out the COM Port number – in this case it is COM67.
7. Start the Freefly Configurator application (first close application and re-run if already open), it should discover the new COM port we have just added. Select the correct COM port from the list and then click "Connect". After a short while the GUI will connect and display an info message. You may now click "Configuration", "Chart", "Heads up display", etc.... "Configuration" and "Chart" are generally 2 items required for tuning.

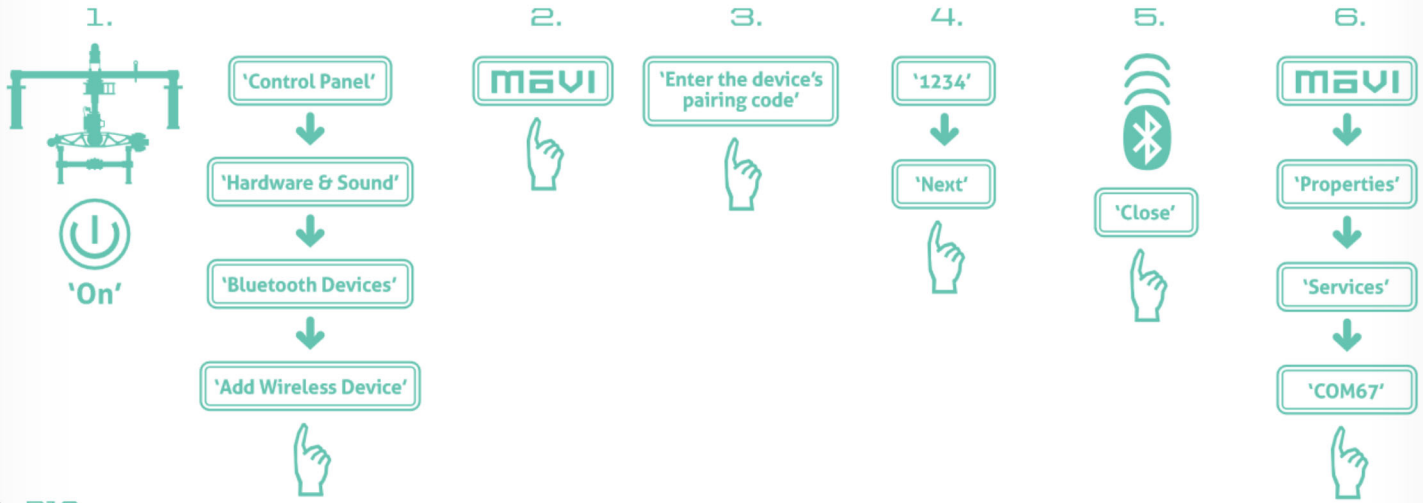

The Freefly Configuration GUI (Graphical User Interface) is the tool that allows you to adjust the software parameters of the MöVI. Changing these parameters will allow you to custom-tailor the MöVI's behavior for particular shots, as well as complete the initial setup required for the MöVI. An important point to note is that you can change parameters in the GUI live with a tablet, but the changes will not be saved unless you write the configuration changes. This tells the MöVI to store the new settings and recall them upon power-up.

GUI/TUNING



INITIAL TUNING:



Above: Freefly MōVI Configuration Graphical User Interface

Now that the camera package is installed and balanced, we can move onto tuning the gimbal. Each time the camera setup changes substantially, the MōVI may need some GUI parameters adjusted. The reason for this is that as you change the weight and balance of the camera and lens substantially, the maximum 'Stiffness' setting that each axis can achieve will change. The primary parameter in the GUI that will need to be adjusted is the 'Stiffness' value for each axis. The 'Stiffness' setting adjusts the degree to which the MōVI tries to correct for unwanted camera movement. The 'Stiffness' setting needs to be set as high as possible without creating unwanted oscillations.

When the 'Stiffness' is set too high, there will be high frequency 'buzzing,' or oscillations. Once these oscillations are felt, the 'Stiffness' setting should be reduced until they stop. It is helpful to reduce the 'Stiffness' setting for each axis to a low value like 10 for initial setup.

STEP 1. TILT STIFFNESS

Under the "Tilt" tab of the GUI, you will find a menu item called "Tilt Stiffness". This parameter will determine how 'stiff' the Tilt Axis will be in holding the camera still. Slowly increase this setting until you feel an oscillation in the Tilt Axis, then reduce the setting until the oscillation subsides. It is important to check that the 'Stiffness' setting you have set will not oscillate in any orientation. To confirm this, point the camera up and down and make sure that the Tilt Axis is stable.

STEP 2. ROLL STIFFNESS

Under the "Roll" tab of the GUI, you will find a menu item called "Roll Stiffness". Slowly increase this setting until you feel an oscillation in the Roll Axis, then reduce the setting until the oscillation subsides. Pick the MōVI up and make sure that you can move the handles around in a normal fashion and that no oscillations are present as you move.

STEP 3. PAN STIFFNESS

Under the "Pan" tab of the GUI, you will find a menu item called "Pan Stiffness". Slowly increase this setting until you feel an oscillation in the Pan Axis, then reduce the setting until the oscillation subsides. Pick up the MōVI and hold it by the center single handle and ensure that no oscillations are present. Holding by the single middle handle is the worst case scenario for "Pan Stiffness" setting.

This concludes the initial gain settings of the gimbal. Now we can move on to setting Majestic Tuning parameters.

MAJESTIC TUNING:

Now that we have the 3 main 'Stiffness' settings dialed-in, we can discuss the various ways that we can tune Majestic Mode. Majestic Mode refers to the single operator mode on the MōVI, where the MōVI operator can control the pan and tilt of the MōVI without the need for a 2nd operator. The MōVI has a difficult task in Majestic Mode; essentially, we are asking the system to provide stable footage, but follow the user's input from the handles. These 2 things are somewhat contradictory. The Majestic Mode tuning parameters in the GUI allow the user to configure the Majestic Mode to suit the particular shot, from very slow and smooth, to very fast and active.

PAN MAJESTIC TUNING:

Pan Majestic Smoothing - This parameter adjusts how much smoothing is applied to the Pan Axis in Majestic Mode. A lower value means the camera will follow the handles more actively, but will make it more difficult to achieve very smooth pans. A higher value will cause the camera to lag behind the handles more, but will allow for very smooth and precise framing when panning. This can be useful when using longer lenses or when subtle moves are needed. A setting of around 5 usually provides a good starting point.

Pan Majestic Window - Pan Majestic Window defines a range in degrees of handle movement which will be ignored. In practice, this means that you can move the handles less than the Pan Majestic Window and the camera will not pan. Once you exceed the Pan Majestic Window threshold, the camera will begin to pan. A normal default setting of 10 is a good place to start. In some circumstances where you will be moving the handles drastically, you can increase the Pan Majestic Window to a much higher value. An example would be when riding a horse or motorcycle with the MōVI. The operator might be unable to keep the handles still, but does not want the camera to pan each time that he/she moves. Setting the Pan Majestic Window to 30 or 40 degrees would mean the operator could move the handles quite drastically without disturbing the shot. The operator could still re-frame the shot by exceeding the threshold.

Pan Majestic Span - Pan Majestic Span alters the amount of rotation from the handles to achieve maximum panning speed. A good default setting is 135 degrees. Too low a setting will make the Majestic Pan

feel too abrupt. A higher setting like 180 degrees is useful for very subtle framing or long lens shots.

TILT MAJESTIC TUNING:

There are a few different Tilt Axis control modes which can be useful for different situations.

Smooth-Lock - In this mode, the tilt angle can be manipulated by the operator. The MōVI operator can manually point the camera at any tilt angle and the MōVI will maintain that tilt angle setting. This can be very useful for scenes where the tilt angle needs to remain constant even as the operator moves around.

Note - If the remote control is turned on and set to "Majestic Mode", it is possible for the remote operator to control tilt while the MōVI operator controls pan.

Majestic Angle - This mode works much the same as the standard Pan Majestic Mode works. It allows the operator to tilt the handles of the MōVI to adjust the camera tilt angle. One important point is that this can be difficult to do with large camera payloads. For these situations, if the operator becomes fatigued, we recommend using the "normal" setting, or a remote operator to control tilt.

GUI PARAMETER DEFINITIONS:

Tuning Menu: This menu contains settings that control the stiffness of each axis, or how much the motors are used for active stabilization. The ideal amount depends on the camera weight and rigidity. For guidelines, refer to the Knowledge Base at www.freeflysystems.com.

Pan Stiffness/Roll Stiffness/Tilt Stiffness - Controls how 'stiffly' the corresponding Axis will try to hold the camera stable. The higher you can run the setting without vibrati on or oscillation, the better.

Majestic Config Menu: This menu controls the behavior of the gimbal when in Majestic Mode.

Pan Smoothing - This parameter adjusts how much smoothing is applied to the Pan Axis in Majestic Mode. A lower value means the camera will follow the handles more actively, but will make it more difficult to achieve very smooth pans. A higher value will cause the camera to lag behind the handles more, but will allow for very smooth motion when panning.

Pan Window - This defines a range (in degrees) of handle pan movement that will be ignored. See further explanation in 'Majestic Tuning' section.

Tilt Mode - Allows you to choose between Smooth Lock and Majestic Angle control. See detailed description in the 'Majestic Tuning' section.

Tilt Smoothing - This parameter adjusts how much smoothing is applied to the Tilt Axis in Majestic Mode. A lower value means the camera will follow the handles more actively, but will make it more difficult to achieve very smooth tilts. A higher value will cause the camera to lag behind the handles more, but will allow for very smooth motion when tilting.

Tilt Window - This defines a range (in degrees) of handle tilt movement that will be ignored. See further explanation in 'Majestic Tuning' section.

General Menu: This menu contains general settings for gimbal behavior.

Gimbal Application - Configures the gimbal for either Handheld or Airborne use. In Handheld use, the center position of the Dual Operator Mode Switch enables Pan Majestic operation. In Airborne use, the center position of the Dual Operator Mode Switch parks the gimbal for takeoff and landing.

Roll Trim - Allows you to input a roll trim to level the camera via the GUI. This roll trim is applied whenever the gimbal is in Majestic Mode. In Dual Operator mode, roll trim is controlled by the Dual Operator Radio Controller. Be sure to write the configuration to the MöVI if you want the roll trim to remain after re-powering the system.

Pan Trim - Allows user to adjust the neutral setting for the Pan Axis. This can be helpful for single operator MR gimbals where you want the camera lens to align with the front of the aircraft

Max Tilt Angle - Sets the maximum angle of the Tilt Axis when looking up. Use to set soft-stops to prevent the camera or lens from hitting the gimbal, or to prevent wires from being pulled out.

Min Tilt Angle - Sets the minimum angle of the Tilt Axis when looking down. Use to set soft-stops to prevent the camera or lens from hitting the gimbal, or to prevent wires from being pulled out.

Remote Operator Config Menu: This menu contains preferences for operation in Dual Operator mode. Use these settings to adjust the feel of the Pan and Tilt joysticks.

Pan Joystick Smoothing - Sets how much smoothing is applied to the Pan Joystick in Dual Operator mode.

Pan Joystick Expo - Sets how much exponential is applied to the Pan Joystick in Dual Operator mode. Higher exponential makes the joystick less sensitive in the center and more sensitive at the edges.

Pan Joystick Window - This defines a range of Pan Joystick movement that will be ignored at the center of the joystick travel.

Tilt Joystick Smoothing - Sets how much smoothing is applied to the Tilt Joystick in Dual Operator mode.

Tilt Joystick Expo - Sets how much exponential is applied to the Tilt Joystick in Dual Operator mode. Higher exponential makes the joystick less sensitive in the center and more sensitive at the edges.

Tilt Joystick Window - This defines a range of Tilt Joystick movement that will be ignored at the center of the joystick travel.

Pan/Tilt Remote Speed Adjustment - Defines whether the Pan and Tilt Rates are controlled together (Combined) or separately (Independent). In Combined mode, the Pan Rate control applies to both Pan and Tilt.

Remote Rate Scale - Default value is 100 deg/sec. Adjustable from 1-200 deg/sec. This value will allow you to increase or decrease the maximum rate available for Pan and Tilt when the remote is in use.

Tilt Control Mode - Tilt can be set to either Rate or Angle mode. Rate is default. Angle mode is recommended for single operator multi-rotor operations where control over Tilt is desired on a dial type knob.

Remote Controller Config Menu: This menu defines how the joysticks and buttons of the Dual Operator Remote Controller are mapped to gimbal movement. Warning- Misconfiguring the remote controller mapping can result in undesired gimbal movement!

Mapping for Spektrum Transmitter

Radio Type	S. DSMX 2048
Map Remote Mode	6
Map Remote Pan	-2
Map Remote Pan Rate	1
Map Remote Tilt	-3
Map Remote Tilt Rate	-7
Map Remote Roll Trim	-4

Mapping for Futaba Transmitter

Radio Type	S. Bus
Map Pan Rate Clamp	-7
Map RC Mode	-5
Map RC Pan	1
Map RC Roll Trim	4
Map RC Tilt	2
Map RC Tilt rate Clamp	6

If you are using the Freefly MöVI Controller, please refer to it's User Manual.

Radio Type – Select the type of radio receiver you are using.

Map Remote Mode – Radio channel corresponding to the three-position Mode Switch.

Map Remote Pan – Radio channel corresponding to the Pan joystick.

Map Remote Pan Rate – Radio channel corresponding to the Pan Speed joystick or knob.

Map Remote Tilt – Radio channel corresponding to the Tilt joystick. To reverse the behavior of the Tilt joystick, use a negative number.

Map Remote Tilt Rate – Radio channel corresponding to the Tilt Speed joystick or knob.

Map Remote Roll Trim – Radio channel corresponding to the Roll Trim switch.

Map Remote Shutter – Radio channel corresponding to the Remote Shutter switch.

Shutter Type – Options are Pulsed, Latched or Camera I/F. Set this for the shutter type of the camera to be used.

Expert Menu: This menu contains expert settings that normally do not need to be adjusted. Leave these settings at the factory default unless they are required for troubleshooting.

Pan/Tilt/Roll Hold Strength Settings – These values control how strongly each axis follows and holds the commanded position. A higher Hold Strength allows faster panning and tilting in Dual Operator and Majestic Mode, but may cause overshoot with heavier cameras. A lower Hold Strength provides additional smoothing. (See Pan/Tilt Joystick Smoothing and Majestic Pan/Tilt Smoothing for other ways to adjust smoothing on each axis.) The default value (8) works well for a large range of cameras.

Gyro Filter – This setting adjusts the strength of the filter applied to the Gimbal's gyro sensors. If the Gimbal is experiencing oscillations that cannot be corrected by adjusting Stiffness settings, you can use the Gyro Filter to further tune the Gimbal and remove oscillations. As a general rule, if the oscillations are fast and rough in nature (buzzing), try increasing the Gyro Filter. If the oscillations are slow and smooth in nature (rocking), try decreasing the Gyro Filter.

Output Filter – This setting adjusts the strength of the filter applied to the Gimbal's motor outputs. If the Gimbal is experiencing oscillations that cannot be corrected by adjusting stiffness settings, you can use the Output Filter to further tune the Gimbal and remove oscillations. As a general rule, if the oscillations are fast and rough in nature (buzzing), try increasing the Output Filter. If the oscillations are slow and smooth in nature (rocking), try decreasing the Output Filter.

Shaky-cam Pan / Tilt – A feature has been exposed to allow operators enhance their filming. Shaky Cam senses movement of the gimbal (acceleration in both the vertical and horizontal axis'), and can add some of that signal into the tilt and pan motors as a form of deliberate pointing corruption. The scaling factors are adjustable where zero disables the corruption, and larger positive or negative values give a progressively stronger lead or lag effect. Lead is where the camera accelerates to tilt more upward when the gimbal is accelerated up, lag is the opposite with the camera briefly pointing more downwards for an up move. Similarly applied for lateral movements affecting the Pan Axis. Both effects may be enabled and tuned independently. The effects may be observed for test purposes by

using larger scaling factors and moving the gimbal around more sharply. It is possible to dial in a relatively consistent behavior suitable for a particular action shot - typically this would be with the camera operator running whilst shooting a scene. The stabilization is otherwise unaffected except for this cyclic operator induced noise.

Setdown Sleep -When set to ON, Setdown Sleep will enable the MöVI to be set down while powered without the use of a stand. This can be useful in situations where the stand is not readily available in a fast moving shooting environment. After sensing the motors are stalled for more than 4 seconds, the MöVI will enter Setdown Sleep mode. While in this mode, the three LEDs on the MöVI will be flashing indicating the sleep state. To exit, simply pick up the MöVI. Although the motors are drawing very little power while in this mode.

Motion Booting – Motion booting bypasses the gyro self test procedure and allows the gimbal to boot up even on a moving platform. It is recommended for situations such as filming from boats. For normal use it is recommended to leave this feature disabled to allow for improved gyro calibration.

Aux Port Function -Selects the function of the Aux Port on the MöVI GCU. Available selections are UART and Shutter where UART is default. Select UART when using the Freefly MöVI Controller to enable communication between the MöVI and the receiver. Select Shutter to enable shutter release or start/stop functionality via other 3rd party controllers. Output signal of the Aux Port when set to shutter: Pin 1 Aux port = GND, Pin 3 Aux port = Shutter input. Map Remote Shutter and Shutter Type settings must also be set.

Heading Assist -Selections available are OFF, Fixed Mount, GPS, and Compass. OFF is default and is no change from how the MöVI performed previous to this update. Fixed Mount is available for use on in stationary type setup such as on a tripod. Using this setting, the MöVI references only motor position during pan moves, thus eliminating drift. When set to GPS this will allow for increased performance during higher accelerations common when used with a multi-rotor platform. Set to Compass for increased handheld performance. A Declination value should be set when in Compass.

Declination -Set local declination value for shooting location. This information is used when Heading Assist is set to Compass. Local magnetic declination values can be found online.

Logging Rate -Available options are 5Hz, 10Hz, and 25Hz logging rates. To be used when Data Logging is set to ON.

Data Logging -Enables logging data from the MöVI via Micro SD card slot on the MöVI GCU. Frequency of data stream can be set via Logging Rate. When Data Logging is set to ON, the LEDs on the MöVI will flash at a frequency corresponding to the Logging Rate setting. Some data may be unavailable without GPS signal or when Heading Assist is set to OFF. To avoid potential corruption of data, Data Logging should be set to OFF before de-powering the MöVI. Data Logging exports a wide range of parameters and is currently available for use in a raw format.

Autotune – MöVI Controller Support 3.08 introduces the ability to automatically calibrate stiffness settings on a balanced MöVI. To initiate the Autotune function, go to SYSTEM-> Autotune. With the MöVI in the stand and stable, Autotune will go through the steps required to tune the MöVI based on the Autotune Percentage setting under Tuning. It is recommended to use the stock setting of 50% for M10s and 70% for dual cage MöVIs such as the M5 and M15.



Separating the tasks of moving the camera and framing the shot allow for unique and dynamic camera moves during high-action scenes. In order to effectively execute such shots, it is imperative that the person holding the MōVI and the person operating the remote control are in sync and understand the other's intentions. Often times, it is helpful to have wireless communication between the MōVI operator and camera operator, so that they can better coordinate moving and framing the camera.

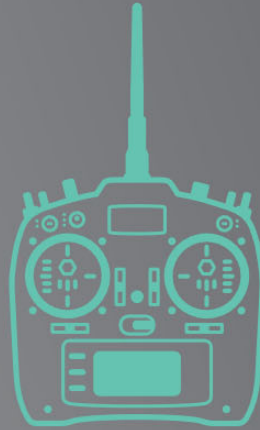

REMOTE CONTROL



REMOTE CONTROL FEATURES:

Tilt Speed: This dial will adjust the speed of the Tilt Axis. High action scenes may require faster speeds, while some scenes require very subtle and delicate framing. The operator can vary the max tilt speed live and on-the-fly by adjusting this dial. Setting the speed as low as possible will give the operator a finer control feel.

Pan Speed: This dial will adjust the speed of the Pan Axis. High action scenes may require faster speeds, while some scenes require very subtle and delicate framing. The operator can vary the max pan speed live and on-the-fly by adjusting this dial. Setting the speed as low as possible will give the operator a finer control feel.

Pan/Tilt Joystick: This is the joystick that allows the operator to control the pan and tilt of the camera. The stick is proportional meaning that the further the operator pushes it in a certain direction, the faster the camera will pan/tilt. It is also important to note that the tilt control can be reversed in the radio software to accommodate the taste of the individual operator.

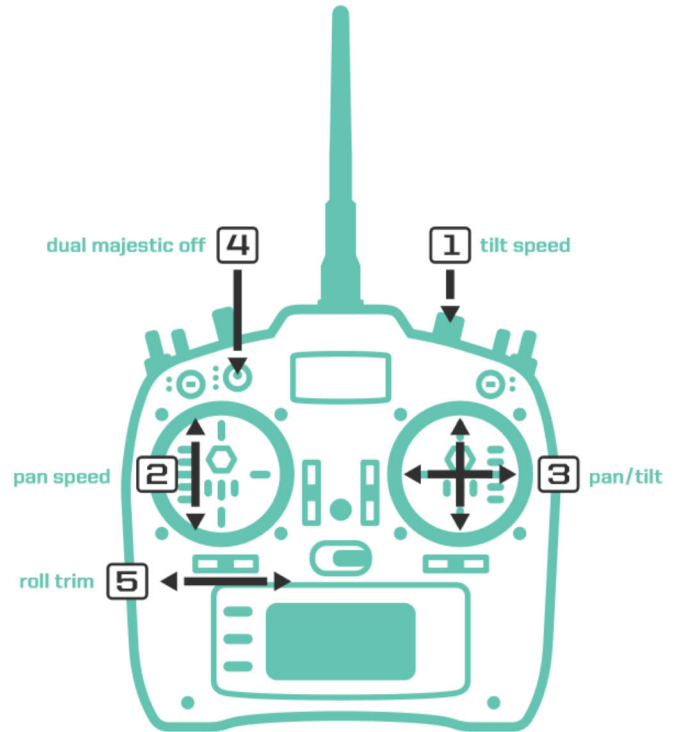

MODE SWITCH:

(DUAL OPERATOR, MAJESTIC, KILL)

Dual Operator Mode: This 3 position switch allows the remote operator to change control modes remotely. The top position is "Remote Operator Mode", which allows the remote operator to have complete control over the gimbal. In this mode, the person holding the MōVI has no control over the camera's pan/tilt. One important point is that when completing a shot, it is helpful if the remote operator switches to Majestic Mode, so that the MōVI operator can move freely with the MōVI without tangling wires, etc. Without switching to Majestic Mode, the MōVI will hold its heading regardless of what the MōVI operator does, which can make it difficult to reset the shot.

Majestic Mode: This refers to the mode which allows the MōVI operator to control both Pan and Tilt Axes or just one of them. For some shots, it is helpful for the MōVI operator to be able to control framing as a single operator. Some shots are best executed with the MōVI operator controlling pan, but with the camera operator controlling tilt.

Kill (Off): This switch position kills power to the MōVI. This is helpful in some cases for setup/initialization or if a wire becomes tangled. In case of any problem or malfunction, the remote operator should immediately activate the kill switch.

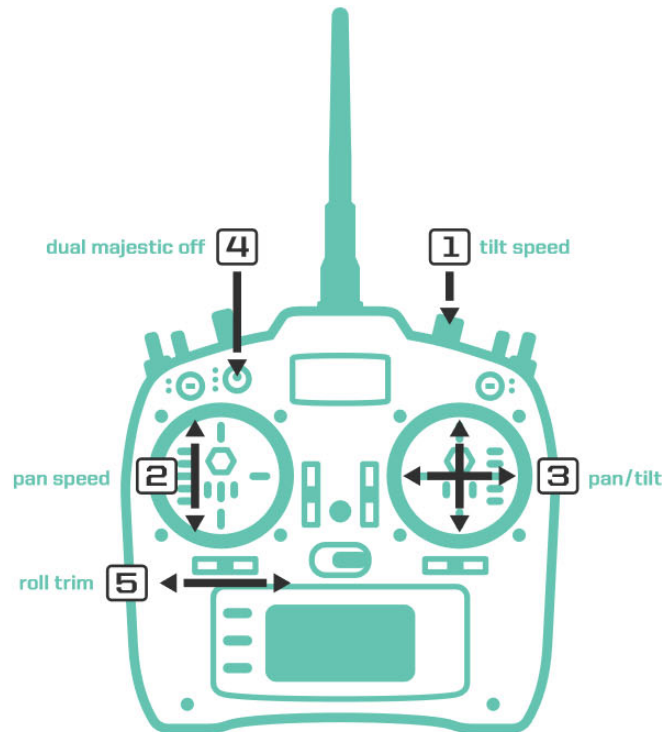



TROUBLESHOOTING



SYMPTOM

POSSIBLE CAUSE

SOLUTION

Gimbal will not power up.
No battery indicator.

Battery unplugged or switch off.
Battery damaged or over-discharged.

Plug in battery and ensure switch is on.
Replace battery. Dispose of used battery properly.

No stabilization, battery indicator shows one rapid flashing LED.



Battery discharged.

Replace battery. Charge the used battery using only the provided charger.

No stabilization, battery indicator shows charge remaining.



Gimbal initializing.
Dual Operator Radio Controller in Kill Mode.

Allow 5 seconds without camera movement for Gimbal to initialize.
Use the Mode Switch on the Radio Controller to activate Dual Operator Mode. Or turn off Radio Controller to return to Majestic mode.

No stabilization, battery indicator shows three flashing LEDs.



Gimbal initialization failed.
A wire has come unplugged.

Restart Gimbal by switching off then on. Allow 5 seconds without camera movement for Gimbal to initialize.
Carefully check all wiring and connectors, especially the IMU Puck wire. Re-seat any loose connections. If a wire has come completely unplugged, refer to the Wiring Diagram for the appropriate connection point.

No stabilization on one axis.

Axis Stiffness is set to 0.
A Motor Drive has been reset due to voltage, temperature, or current protection.
A Motor Wire has come unplugged.

Open the GUI. On the Tuning page, ensure that the axis Stiffness is not set to zero.
Restart the Gimbal by switching off then on.
Power off the Gimbal. Reconnect the Motor Wire. Refer to the Wiring Diagram for proper connections.

Gimbal attempts to stabilize camera to an improper orientation.

Gimbal initialized in improper orientation.
The camera must be correctly oriented during initialization.
Gimbal joints have been modified.

Restart Gimbal by switching off then on. Ensure that the camera and Gimbal are in the desired orientation during initialization.
The Gimbal joints should never be disassembled except by qualified technicians.

SYMPTOM

POSSIBLE CAUSE

SOLUTION

Pan Axis is offset by 90° or 180° in Majestic Mode.

Handle has been attached in an incorrect orientation.

If you have disassembled the handle (for example to switch from handheld to multirotor use), be sure to reassemble in the original orientation.

Oscillation on one more Gimbal axis.

Stiffness setting is too high.

Reduce the Stiffness setting of the axis that is oscillating using the GUI Tuning page. (You can use the GUI Motors Chart to see which axis is oscillating if it isn't visible.)

An Adjustment Clamp is not tightened.

Check all Adjustment Clamps for adequate tightness. They must all be locked down during operation. If necessary, adjust the clamp tension with a hex wrench.

Camera mounting is not stiff enough.

The camera must be mounted rigidly to the Tilt Axis. Use a wedge or spacer under the lens and/or on the sides of the camera to stiffen the mounting if necessary.

Filter settings are incorrect. Note: The Gyro and Output filters are advanced settings and should only be modified if other methods of reducing oscillation have failed.

If the oscillations are fast (buzzing), try increasing the Filter settings under GUI Expert Settings. If they are slow (rocking), try decreasing the Filter settings.

Poor stabilization. (Bumps or jolts present in footage.)

The gimbal is not adequately balanced.

Check the camera balance in various positions. Repeat balancing steps as described in the user manual.

The Stiffness setting is too low.

Increase the Stiffness settings of each axis in the GUI Tuning page. If you can identify which axis is poorly stabilized, start with that axis' Stiffness. Higher Stiffness will achieve better stabilization. The tuning process is described in the user manual.

Horizon (Roll Axis) is not level.

Roll Trim not set.

Adjust the Roll Trim setting to achieve a level horizon. In Majestic Mode, this is adjustable in the GUI. In Dual Operator mode, this is adjustable using the Roll Trim switch on the Dual Operator Radio Controller.

No Control in Dual Operator Mode.

Dual Operator Radio Controller is off, or set to Kill or Majestic Mode.

Turn on Radio Controller and set Mode Switch to Dual Operator (DUAL) Mode.

Radio Controller Mapping is misconfigured.

If you are using the stock Radio Controller (Spektrum DX7), ensure that the Radio Mapping settings in the GUI are as shown on P24.

If you are using another Radio Controller, refer to the User Manual for guidance on Radio Mapping.

WARRANTY:

Freefly warrants product purchased ("Product") will be of good quality and workmanship and free from material defects. Upon the expiration of the time periods below, all liabilities of Freefly will terminate. In no event shall Freefly be liable for consequential damages. Freefly may use refurbished parts for repairs or replacements. Certain products may be subject to a separate software license agreement.

Standard Warranty

A Standard Warranty is granted to the original purchaser by Freefly for a period of one (1) year, parts and labor. The Standard Warranty does not apply to batteries. The Standard Warranty covers parts and labor charges for Product that has been returned pre-paid shipment to an Authorized Service Center. Service or replacement decisions are at the sole discretion of Freefly. Proof of purchase is required for warranty claims. All warranty returns shall be done in accordance with Freefly's warranty Return Merchandise Authorization ("RMA") policy, which can be found on our website. Any repaired or replaced Product shall be warranted as set forth in this section for a period the greater of (i) the balance of the applicable warranty period relating to such Product or (ii) ninety (90) days after it is received by Buyer. Only the components that were repaired or replaced will be eligible for the 90-day period as set forth above. The Standard Warranty effective date is the date of "ex works" from Woodinville, Washington.

Exclusive Battery Warranty

Freefly warrants that batteries purchased or included with the Product will be free from defects in materials and workmanship at the date of purchase by Buyer. Battery product warranty is limited to original defects in material and workmanship. Due to the nature and use of these batteries, there is no term warranty. Misuse, abuse, incorrect charging, failure to comply with applicable battery warnings and guidelines, and other inappropriate use of the batteries are not covered under this warranty.

Warranty Limitations

All Freefly warranties do not cover (a) maintenance, repair or replacement necessitated by loss or damage resulting from any cause other than normal use and operation of the Product in accordance with Freefly's specifications and owner's manual, including but not limited to: theft, exposure to weather conditions, operator negligence, misuse,

abuse, improper electrical/power supply; (b) alterations, modifications or repairs by Buyer or unauthorized third parties; (c) accident, disaster, improper handling or storage, droppage, modification, opening sealed components, use of third party accessories or acts of nature or any other peril originating from outside the Product; (d) transportation damage, lack of or improper maintenance, defective batteries, battery leakage; and (e) cosmetic damage or other non-operating parts. Removal or modification of sealed components, including but not limited to, motors or electronics, voids any and all warranties. Breaking the seal on any sealed components, including but not limited to motors or electronics, is prohibited and voids any and all warranties unless otherwise approved by Freefly. Any parts replaced by Freefly during warranty repair are the property of Freefly and will not be returned to Buyer. Freefly may use refurbished parts for repairs or replacements.

Freefly products are compatible with Freefly software, Freefly parts and Freefly products only. Use of any software, parts, or products, other than Freefly or Freefly approved software, parts, and products, which plug into or directly affect the function or performance of Freefly products voids any and all warranties.

Limitation of Liability

EXCEPT AS SPECIFICALLY SET FORTH ABOVE, FREEFLY AND ITS LICENSORS MAKE NO WARRANTIES, CONDITIONS, REPRESENTATIONS OR TERMS, EXPRESS OR IMPLIED, WHETHER BY STATUTE, COMMON LAW, CUSTOM, USAGE OR OTHERWISE AS TO THE FREEFLY PRODUCT OR ANY COMPONENT THEREOF, INCLUDING BUT NOT LIMITED TO NON-INFRINGEMENT OF THIRD PARTY RIGHTS, INTEGRATION, MERCHANTABILITY, SATISFACTORY QUALITY, OR FITNESS FOR ANY PARTICULAR PURPOSE. FREEFLY AND ITS LICENSORS DO NOT WARRANT THE PERFORMANCE OR RESULT OF THE FREEFLY PRODUCT.

THE SOLE REMEDY UNDER THIS WARRANTY SHALL BE THE REPAIR, REPLACEMENT, OR CREDIT FOR DEFECTIVE PARTS AS STATED ABOVE. THIS WARRANTY IS THE SOLE WARRANTY GIVEN BY FREEFLY AND IS IN LIEU OF ANY OTHER WARRANTIES EITHER EXPRESS OR IMPLIED. THIS WARRANTY EXTENDS TO THE BUYER AND IS NON-TRANSFERABLE TO OTHER THIRD PARTIES.

FREEFLY SHALL NOT BE LIABLE FOR SPECIAL, INDIRECT, INCIDENTAL OR CONSEQUENTIAL DAMAGES, LOSS OF PROFITS OR PRODUCTION OR COMMERCIAL LOSS IN ANY WAY, REGARDLESS OF WHETHER SUCH CLAIM IS BROUGHT IN CONTRACT, WARRANTY, TORT, NEGLIGENCE, STRICT LIABILITY OR ANY OTHER THEORY OF LIABILITY, EVEN IF FREEFLY HAS BEEN ADVISED OF THE POSSIBILITY OF SUCH DAMAGES. IN NO EVENT SHALL THE LIABILITY OF FREEFLY EXCEED THE INDIVIDUAL PRICE OF THE PRODUCT ON WHICH LIABILITY IS ASSERTED.

Non-Warranty Repair

Product that no longer qualifies for Warranty Repair may be sent to an Authorized Freefly Service Center subject to an evaluation fee. Freefly will provide a quotation for the repair of the Product. The Customer is responsible for all costs associated with such refurbishment, such as troubleshooting, diagnosis, repair, test, calibration, storage, and shipping costs. The evaluation fee will be applied to the cost of the refurbishment if the cost of the refurbishment is greater than the evaluation fee. Any repaired or replaced product shall be warranted for ninety (90) days after it is received by Buyer. Only the components that were repaired or replaced will be eligible for the 90-day period. Any parts replaced by Freefly during non-warranty repair are the property of Freefly and will not be returned to Buyer. Freefly may use refurbished parts for non-warranty repair.

Law Governing

These terms are governed by Washington State law (without regard to conflict of law principles or the United Nations Convention on Contracts for the International Sale of Goods.) Freefly reserves the right to change or modify this warranty at any time without notice. For up-to-date warranty information, visit www.freeflysystems.com.



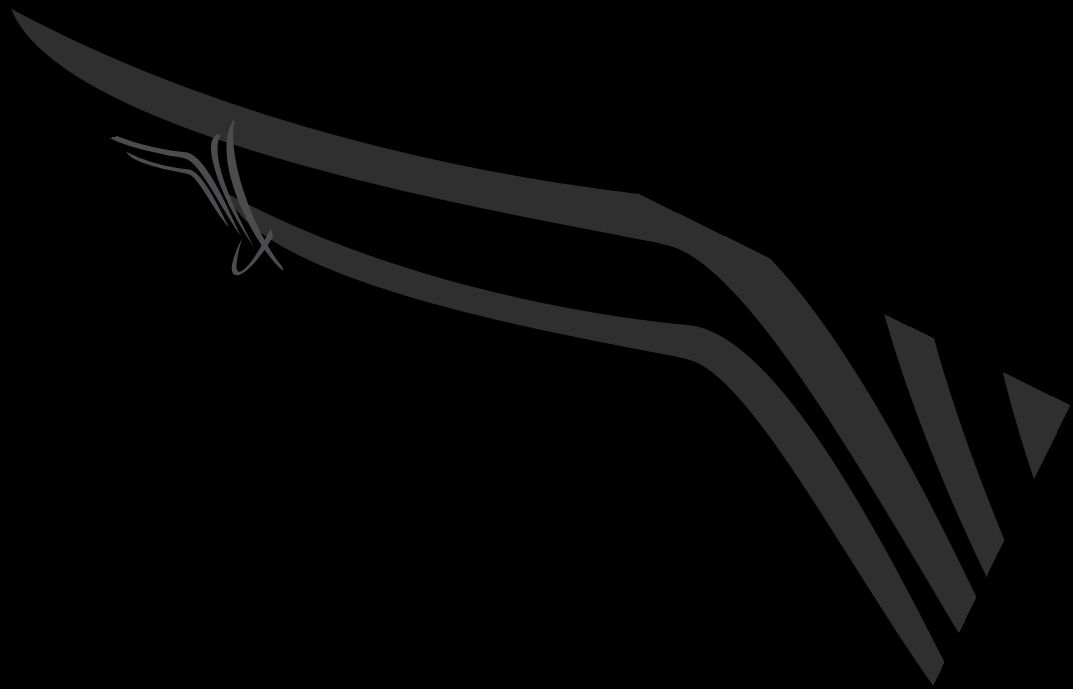

WWW.FREEFLYSYSTEMS.COM